

Dental

Elevators	47
Extracting Forceps	48
Tooth Forceps	51
Wire Cutting Forceps	53



Bein Elevator

140mm long

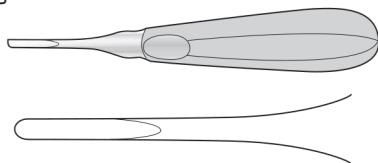

Straight

Code	Description
SC-DEN/8348	2mm wide
SC-DEN/8346	2.5mm wide
SC-DEN/8344	3mm wide
SC-DEN/8342	3.5mm wide
SC-DEN/8340	4mm wide

Curved

Code	Description
SC-DEN/8352	2mm wide
SC-DEN/8347	2.5mm wide
SC-DEN/8345	3mm wide
SC-DEN/8343	3.5mm wide
SC-DEN/8341	4mm wide

Coleman Elevator

145mm long



Code	Description
SC-DEN/8294	Left

Code	Description
SC-DEN/8295	Right

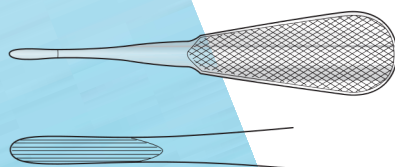

Code	Description
SC-DEN/8273	Straight

Coupland Elevator

Curved, 150mm long



Code	Description
SC-PL/068	3mm wide - Ash no1
SC-PL/068a	4mm wide - Ash no2
SC-PL/068b	5mm wide - Ash no3

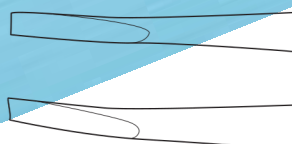

Cryer-White Elevator

150mm long

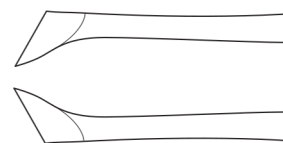

Code	Description
SC-DEN/8261	Left
SC-DEN/8263	Right

Cryer Elevator

150mm long

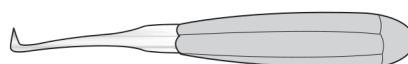

Code	Description
SC-PL/069	Right
SC-PL/069a	Left



Warwick-James Elevator

150mm long



Code	Description
SC-DEN/8275	Straight
SC-DEN/8249	Left
SC-DEN/8251	Right

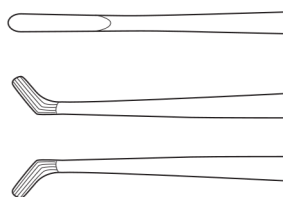

Winter Elevator

105mm long

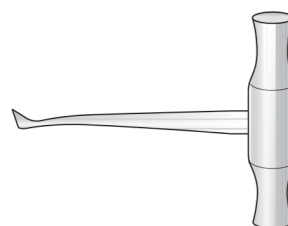

Code	Description
SC-DEN/8338	Left
SC-DEN/8358	Right

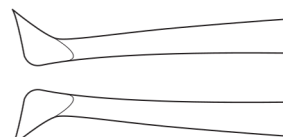

Extracting Forceps

Extracting Forceps

For lower molars with decayed or broken crowns either side molars
180mm long

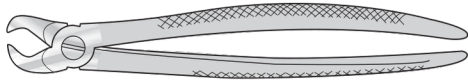

Code	Description
SC-DEN/8578	No 87



Extracting Forceps

For lower molars either side
165mm long

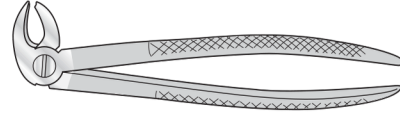

Code	Description
SC-DEN/8522	No 22

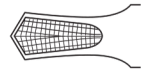

Extracting Forceps

For upper roots
180mm long

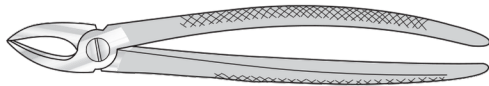

Code	Description
SC-DEN/8530	No 30

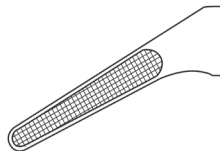

Extracting Forceps

For upper roots and incisors
165mm long

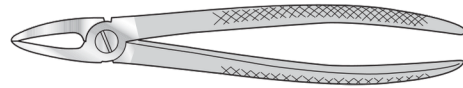

Code	Description
SC-DEN/8522a	No 29

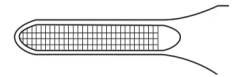

Extracting Forceps

For upper molars
180mm long

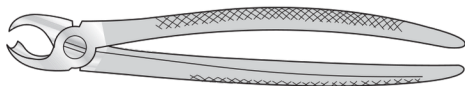

Code	Description
SC-DEN/8588	No 89
SC-DEN/8590	No 90

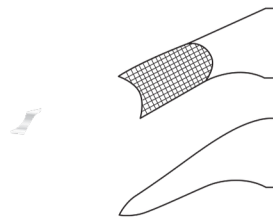

Extracting Forceps

For upper laterals and canines
170mm long

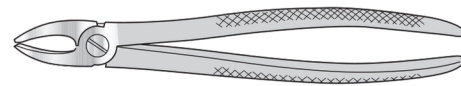

Code	Description
SC-DEN/8500	No 1, 6mm
SC-DEN/8502	wide No 1, 5mm wide

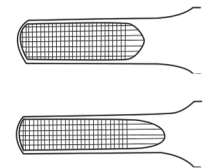

Extracting Forceps

For lower molars
165mm long

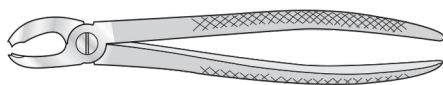

Code	Description
SC-DEN/8520	No 21

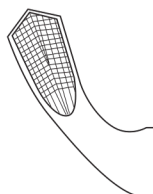

Extracting Forceps

For lower incisors and canines
170mm long

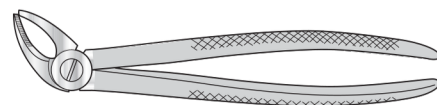

Code	Description
SC-DEN/8504	No 4, 4mm wide

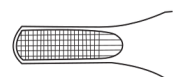

Extracting Forceps

Extracting Forceps

For lower premolars
170mm long

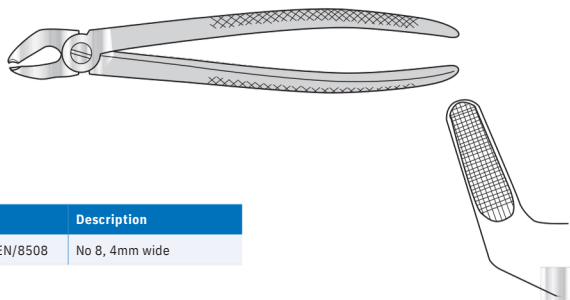

Code	Description
SC-DEN/8508	No 8, 4mm wide

Extracting Forceps

For lower molars
150mm long

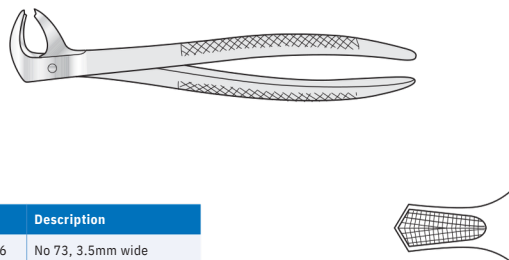

Code	Description
SC-DEN/8566	No 73, 3.5mm wide

Extracting Forceps

For lower bicuspid and canines
170mm long

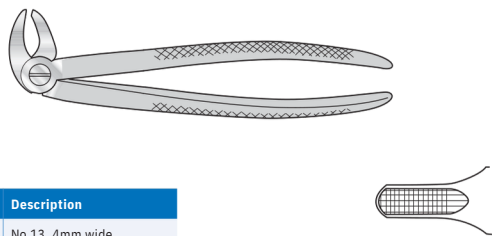

Code	Description
SC-DEN/8512	No 13, 4mm wide

Extracting Forceps

For lower roots
150mm long

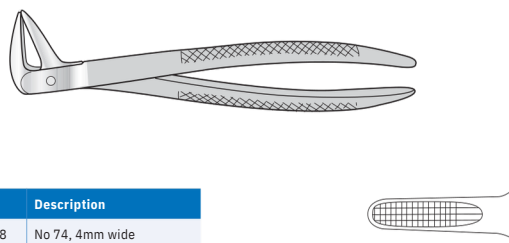

Code	Description
SC-DEN/8568	No 74, 4mm wide

Extracting Forceps

For upper premolar
180mm long

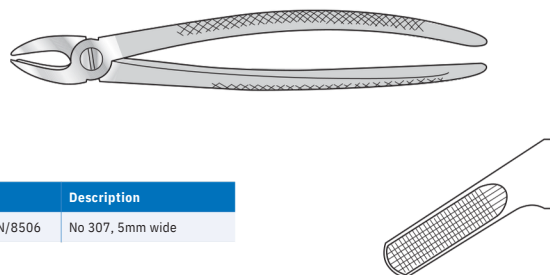

Code	Description
SC-DEN/8506	No 307, 5mm wide

Extracting Forceps

For lower roots and premolars
150mm long

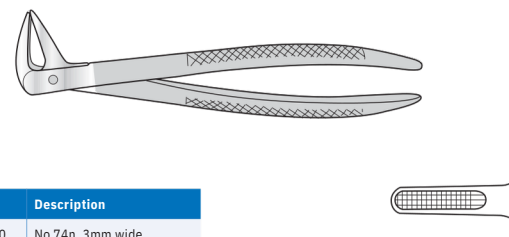

Code	Description
SC-DEN/8570	No 74n, 3mm wide

Extracting Forceps

For upper molars
180mm long

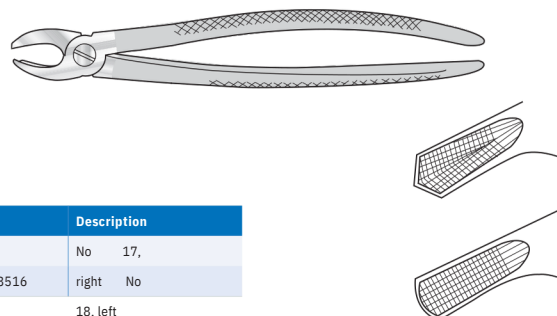

Code	Description
SC-DEN/8516	No 17, right
SC-DEN/8518	No 18, left

Extracting Forceps

For lower bicuspid and canines
150mm long

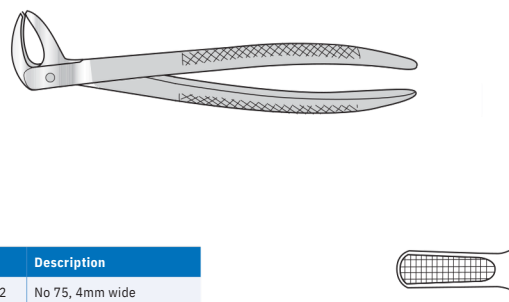

Code	Description
SC-DEN/8572	No 75, 4mm wide

Extracting Forceps

Extracting Forceps

For lower molars with decayed or broken crowns either side
150mm long

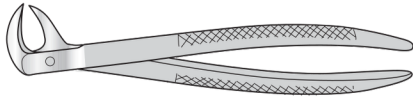

Code	Description
SC-DEN/8576	No 86a

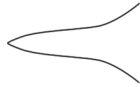

Extracting Forceps

For upper roots, narrow
185mm long

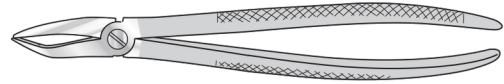

Code	Description
SC-DEN/8552	No 51a, 3mm wide

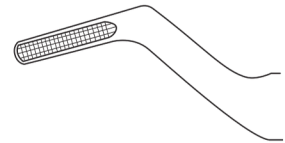

Extracting Forceps

For lower roots either side
165mm long

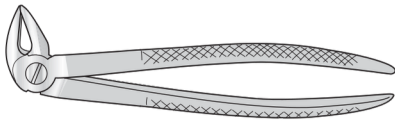

Code	Description
SC-DEN/8532	No 33, 3.5mm wide

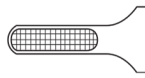

Extracting Forceps

For upper wisdoms either side
185mm long

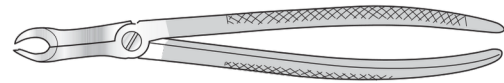

Code	Description
SC-DEN/8560	No 67, 7mm wide

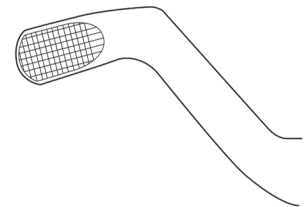

Extracting Forceps

For upper roots
185mm long

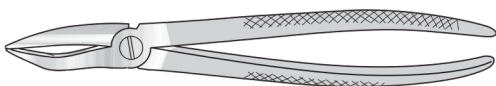

Code	Description
SC-DEN/8550	No 51, 4mm wide

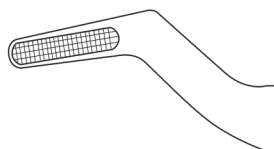

Extracting Forceps

For lower wisdoms either side
185mm long

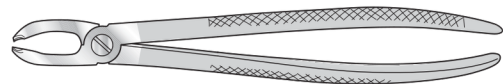

Code	Description
SC-DEN/8574	No 79, 5mm wide

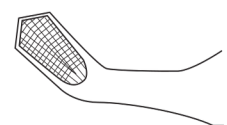

Cryer Tooth Forceps

For upper incisors and roots
185mm long

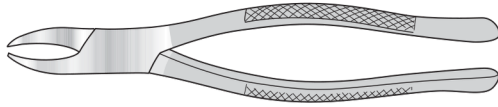

Code
SC-DEN/8010

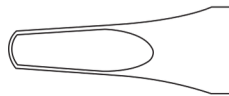

Cryer Tooth Forceps

For incisors and roots
185mm long

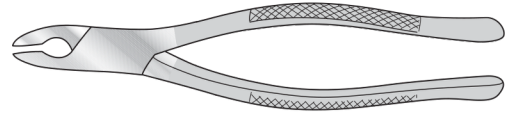

Code	Description
SC-DEN/8013	No 150a

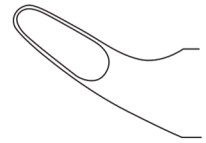

Cryer Tooth Forceps

For incisors and roots
185mm long

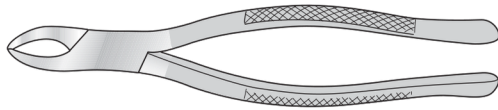

Code	Description
SC-DEN/8014	No 62

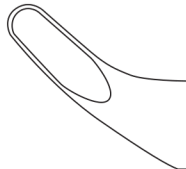

Tooth Forceps

For lower incisors, bicuspid and roots
185mm long

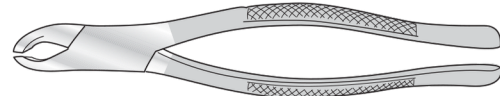

Code	Description
SC-DEN/8036	No 203

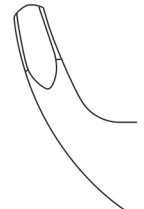

Cryer Tooth Forceps

For upper incisors and roots
185mm long

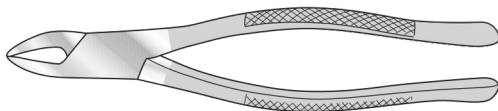

Code	Description
SC-DEN/8012	No 150

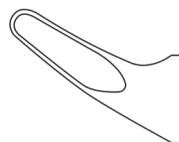

Tooth Forceps

For lower molars either side
185mm long

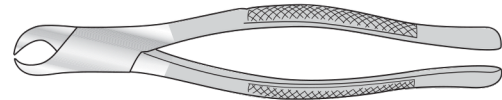

Code	Description
SC-DEN/8039	No 23

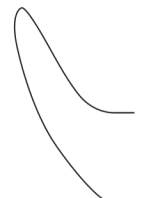

Tooth Forceps

Tooth Forceps

For lower molars
185mm long

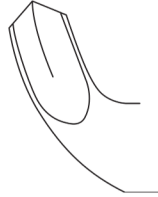
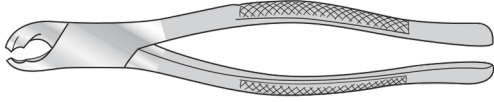

Code	Description
SC-DEN/8042	No 17

Tooth Forceps

For lower roots, incisors and bicuspid
175mm long

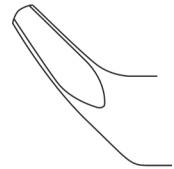
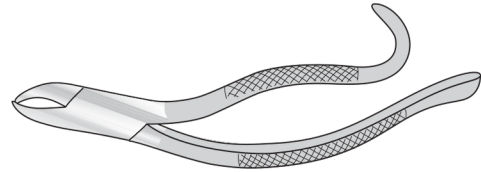

Code	Description
SC-DEN/8045	No 103

Tooth Forceps

For lower wisdom teeth
185mm long

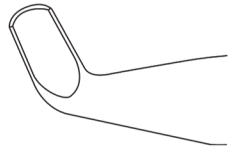
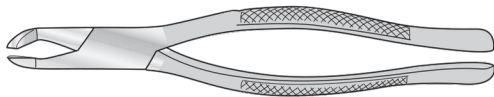

Code	Description
SC-DEN/8043	No 222

Tooth Forceps for Children

160mm long

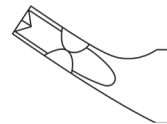
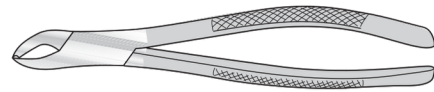

Code	Description
SC-DEN/8037	No 151as, for lower teeth

Code	Description
SC-DEN/8017	No 150as, for upper teeth

Tooth Forceps

For lower molars either side
175mm long

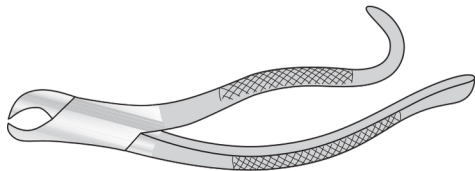

Code	Description
SC-DEN/8040	No 16

Cryer Tooth Forceps for Children

For upper incisors, canines and bicuspid,
160mm long

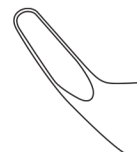
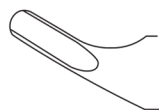
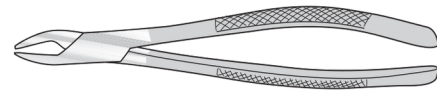

Code	Description
SC-DEN/8011	No 1505

Code	Description
SC-DEN/8033	No 1515

Top Cutting Forceps

Tungsten carbide edge, for bone pins up to 2.5mm \varnothing
gold handles

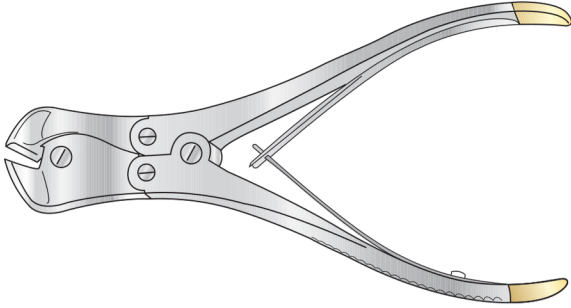

Code	Description
SC-OR/06	215mm long

Side Cutting Forceps

Tungsten carbide edge, for bone pins up to 2.2mm \varnothing
gold handles

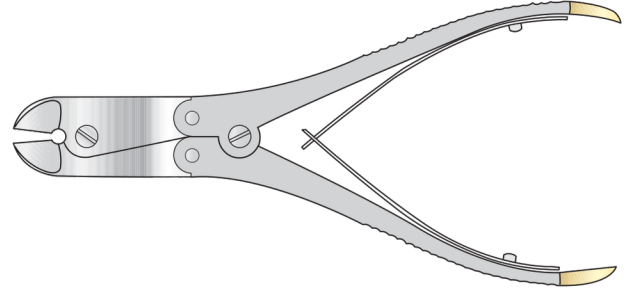

Code	Description
SC-OR/332	230mm long

Top Cutting Forceps

Tungsten carbide edge, for arthrodesis wire up to 1.5mm \varnothing
gold handles

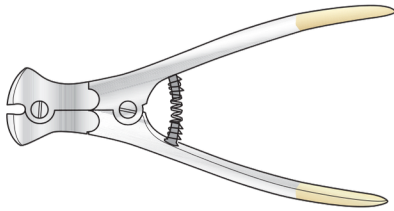

Code	Description
SC-OR/06a	145mm long