

Surgical Instruments



Gayoor Industry

Artery Forceps

Adson Artery Forceps

Box joint, 180mm long

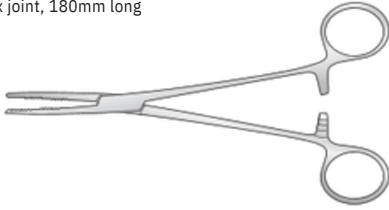

Serrated jaws

Code	Description
SC-GI/034	Straight
SC-GI/034a	Curved

1-2 teeth

Code	Description
SC-GI/034b	Straight
SC-GI/034c	Curved

Cushing Artery Forceps

Box joint, fine, half serrated jaws, 140mm long

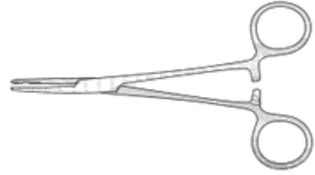

Code	Description
SC-GI/001	Straight
SC-GI/002	Curved

Cairns Artery Forceps

Box joint, half serrated jaws
145mm long

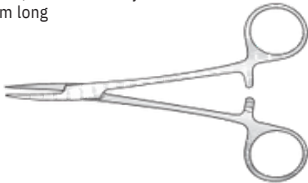

Serrated jaws

Code	Description
SC-GI/415	Straight

1-2 teeth

Code	Description
SC-GI/020	Curved
SC-GI/021	Curved to side

Dunhill Artery Forceps

Box joint, fine serrations

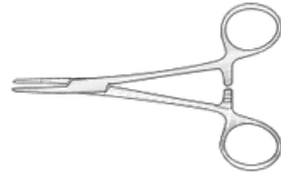

Straight

Code	Description
SC-GI/065	135mm
SC-GI/065a	long
	190mm
	long

Curved

Code	Description
SC-GI/043	135mm
SC-GI/468	long
	180mm
	long

Crile Artery Forceps

Box joint, serrated jaws

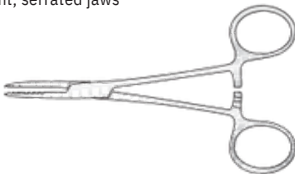

Straight

Code	Description
SC-GI/014	140mm
SC-GI/014a	long
	160mm
	long

Curved

Code	Description
SC-GI/015	140mm
SC-GI/015a	long
	160mm
	long

Lawson Tait Artery Forcep

Box joint, straight jaw



Code	Description
SC-GI/SH5924	140mm long

Halstead Mosquito Forceps

Standard pattern, haemostatic, box joint

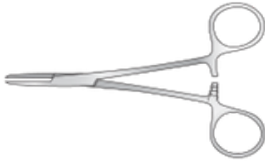

Serrated jaw

Code	Description
SC-GI/007	Straight 125mm long
SC-GI/008	Curved 125mm long
SC-GI/009	Fully curved 125mm long

1-2 teeth

Code	Description
SC-	Straight 125mm long
GI/010	Straight 190mm long
SC-	Curved 125mm long
GI/012	Curved 190mm long

SC-

GI/011

SC-

GI/013

Heiss Artery Forceps

Box joint, 205mm long

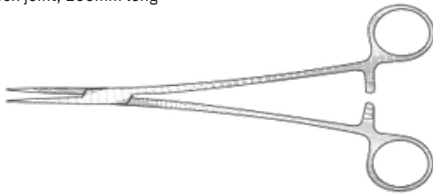

Serrated jaws

Code	Description
SC-	Straight
GI/016	Curved
SC-	
GI/017	

1-2 teeth

Code	Description
SC-	Straight
GI/016a	Curved
SC-	
GI/017b	

Kelly Artery Forceps

Box joint, half serrated jaws



Straight

Code	Description
SC-	140mm
GI/022	long
SC-	160mm
GI/023	long

Curved

Code	Description
SC-GI/024	140mm
SC-GI/025	long
	160mm
	long

Fraser Kelly Artery Forceps Curved

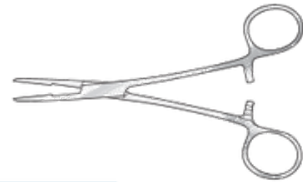

Straight

Code	Description
SC-GI/468a	180mm

Kocher Artery Forceps

Box joint, 1-2 teeth



Straight

Code	Description
SC-GI/052	130mm long
SC-GI/053	150mm long
SC-GI/054	180mm long
SC-GI/055	200mm long
SC-GI/056	230mm long

Curved

Code	Description
SC-GI/057	150mm long
SC-GI/058	180mm long
SC-GI/059	200mm long
SC-GI/060	230mm long

Artery Forceps

Moynihan Artery Forceps

Box joint, half-serrated jaws



Straight

Code	Description
SC-GI/018	145mm
SC-GI/068	long
	180mm long

Curved

Code	Description
SC-GI/019	145mm long
SC-GI/069	180mm long

Rochester-Pean Artery Forceps

Box joint

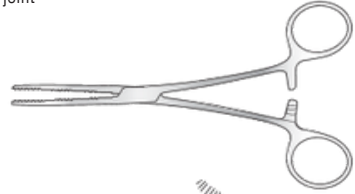

Straight

Code	Description
SC-GI/044	165mm long
SC-GI/045	190mm long
SC-GI/046	205mm long
SC-GI/047	240mm long

Curved

Code	Description
SC-GI/048	165mm long
SC-GI/049	180mm long
SC-GI/050	205mm long
SC-GI/051	240mm long

Roberts Artery Forceps

Screw joint, curved on fl at, serrated



Code	Description
SC-GI/070	230mm long

Spencer Wells Artery Forceps

Box joint, serrated jaws

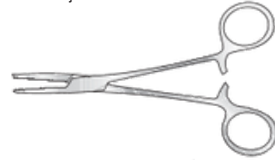

Straight

Code	Description
SC-GI/035	127mm long
GI/035	152mm long
SC-GI/036	177mm long
GI/036	203mm long

Curved

Code	Description
SC-GI/039	127mm long
SC-GI/040	152mm long
SC-GI/041	177mm long
SC-GI/042	203mm long

OTHER SIZES AVAILABLE

SC-GI/038

Dandy Artery Forceps

Box joint, curved in plane

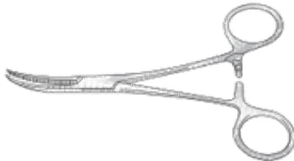

Code	Description
SC-GI/076	140mm long

Carmalt Angiotribe Forceps

Box joint, atraumatic, light pattern

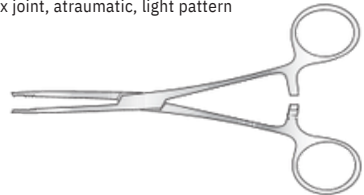

Straight

Code	Description
SC-GI/062	165mm long
SC-GI/063	200mm long
SC-GI/064	230mm long

Curved

Code	Description
SC-GI/061	165mm long

Dieff enbach Bulldog Clamp



Straight, serrated

Code	Description
SC-GI/112	1.2mm fi ne jaw, 40mm long
SC-GI/113	1.2mm fi ne jaw, 45mm long
SC-GI/108	1.8mm jaw, 30mm long
SC-GI/109	1.8mm jaw, 35mm long
SC-GI/110	2.5mm jaw, 40mm long
SC-GI/111	2.5mm jaw, 45mm long
SC-GI/107	6mm heavy jaw, 60mm long
SC-GI/455	20mm jaw, 75mm long
SC-GI/455a	30mm jaw, 85mm long
SC-GI/455b	45mm jaw, 105mm long
SC-GI/455c	65mm jaw, 120mm long

Straight, plain

Code	Description
SC-	1.2mm fi ne jaw, 40mm long
GI/129	1.2mm fi ne jaw, 45mm long
SC-	1.8mm jaw, 30mm long
GI/131	1.8mm jaw, 35mm long
SC-	2.5mm jaw, 40mm long
GI/121	2.5mm jaw, 45mm long
SC-	
GI/123	
SC-	
GI/125	
GI/127	

Curved, serrated

Code	Description
SC-GI/119	1.2mm fi ne jaw, 40mm long
SC-GI/120	1.2mm fi ne jaw, 45mm long
SC-GI/115	1.8mm jaw, 30mm long
SC-GI/116	1.8mm jaw, 35mm long
SC-GI/117	2.5mm jaw, 40mm long
SC-GI/118	2.5mm jaw, 45mm long
SC-GI/114	6mm heavy jaw, 60mm long
SC-GI/456	20mm jaw, 75mm long
SC-GI/456a	30mm jaw, 85mm long
SC-GI/456b	45mm jaw, 105mm long
SC-GI/456c	65mm jaw, 120mm long

Curved, plain

Code	Description
SC-	1.2mm fi ne jaw, 40mm long
GI/130	1.2mm fi ne jaw, 45mm long
SC-	1.8mm jaw, 30mm long
GI/132	1.8mm jaw, 35mm long
SC-	2.5mm jaw, 40mm long
GI/122	2.5mm jaw, 45mm long
SC-	
GI/124	
SC-	
GI/126	
SC-	
GI/128	

Blalock Bulldog Clamp



Serrated, with hole in handle

Straight

Code	Description
SC-GI/480	11mm jaw, 38mm long
SC-GI/482	14mm jaw, 48mm long
SC-GI/493	17mm jaw, 60mm long
SC-GI/481	27mm jaw, 70mm long

Curved

Code	Description
SC-	11mm jaw, 38mm long
GI/478	14mm jaw, 48mm long
SC-	17mm jaw, 60mm long
GI/479	27mm jaw, 70mm long
SC-	
GI/491	
SC-	
GI/492	

Plain, with hole in handle

Straight

Code	Description
SC-	11mm jaw, 38mm long
GI/486	14mm jaw, 48mm long
SC-	17mm jaw, 60mm long
GI/487	27mm jaw, 70mm long
SC-	
GI/488	
SC-	
GI/489	

Curved

Code	Description
SC-GI/483	11mm jaw, 38mm long
SC-GI/484	14mm jaw, 48mm long
SC-GI/485	17mm jaw, 60mm long
SC-GI/490	27mm jaw, 70mm long

An Overview On

Forcep Jaw Types

You will see that forceps in our catalogue will have either a traditional serrated jaw or a different design which is known as atraumatic (or non-traumatic).

Traditional Serrated Jaw



The traditional serrated jaw is generally more robust and used on forceps where the areas are not as delicate.

Atraumatic Jaw



Atraumatic jaws will be mainly found in delicate surgery areas such as vascular and cardiothoracic. The design is such, that the surface area gripped is reduced, ensuring less trauma without the loss of grip.

Spring Forceps

Adsons Dissecting Forceps



127mm long

Code	Description
SC-	1-2 teeth
GI/257	Lightweight, micro
SC-	Serrated
GI/258	Serrated, lightweight, micro
SC-	

GI/259

Block End Dissecting Forceps

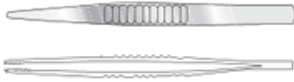

Serrated

Code	Description
SC-GI/255	127mm long
SC-GI/256	152mm long
SC-GI/256a	203mm long

Bonney Dissecting Forceps

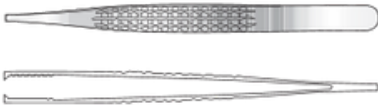

178mm long

Code	Description
SC-	Serrated, 1-2 teeth
GI/267	1-2 teeth
SC-	
GI/268	

Charnley-McIndoe Dissecting Forceps

150mm long



Code	Description
SC-OR/N045a	2-3 teeth

DeBakey Atraumatic Dissecting Forceps

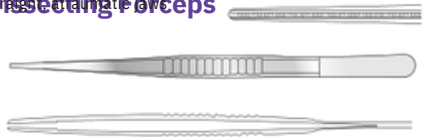

1.5mm

Code	Description
SC-	150mm long
GI/238a	240mm long
SC-	
GI/240a	

2.5mm

Code	Description
SC-	150mm long
GI/238b	240mm long
SC-	
GI/240b	

2mm

Code	Description
SC-	150mm
GI/238	long
SC-	180mm
GI/241	long

2.8mm

Code	Description
SC-	150mm long
GI/238c	240mm long
SC-	180mm long
GI/240c	
SC-	
GI/241c	

Dissecting Forceps

Turnover end, serrated jaws



Code	Description
SC-	127mm
GI/242	long
SC-	152mm
GI/243	long

Code	Description
SC-	178mm long
GI/244	203mm long
SC-	
GI/245	

Dunhill Dissecting Forceps

Light, fine serrated jaws



Code	Description
SC-GI/457	145mm long

Fredrick Coolé Dissecting Forceps

Extra fine serrated jaws



125mm long

Code	Description
SC-GI/066	Straight
SC-GI/067	Curved

Gillies Dissecting Forceps

1-2 teeth

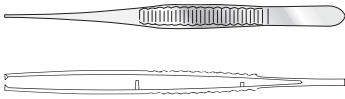

Code	Description
SC-PL/052	152mm long

McIndoe Dissecting Forceps

152mm long



Code	Description
SC-	Serrated
GI/476	1-2 teeth
SC-	teeth
GI/477	

Jackson Burrows Dissecting Forceps

140mm long

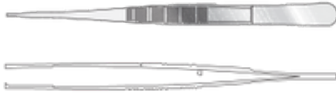

Code	Description
SC-OR/N037	Tongue and groove, 1-2 teeth
SC-OR/N037a	Tongue and groove only

McIndoe Modified Dissecting Forceps

152mm long, 1mm tip, modified for fine powerful dissection with strong action tip



Code	Description
SH/5961	Serrated

Jean Dissecting Forceps

Serrated jaws, 140mm long

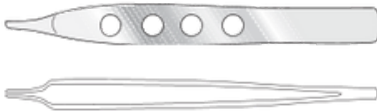

Code	Description
SC-	Fine
GI/269	1-2 teeth
SC-	2-3 teeth, 178mm long
GI/270	
SC-	
GI/271	

Treves Dissecting Forceps



1-2 teeth

Code	Description
SC-	127mm
GI/251	long
SC-	152mm
GI/252	long

2-3 teeth

Code	Description
SC-	127mm
GI/253	long
SC-	152mm
GI/254	long

Lanes Dissecting Forceps

1-2 teeth on serrated jaws, 140mm long



Code	Description
SC-	127mm
GI/246	long
SC-	152mm
GI/247	long
SC-	178mm
GI/248	long

Code	Description
SC-GI/249	2-3 teeth, 178mm
SC-GI/250	long 2-3 teeth 203mm

Waugh Dissecting Forceps



Fine, serrated

Code	Description
SC-	152mm long
GI/261	178mm long
SC-	203mm long
GI/262	
SC-	
GI/263	

Fine, 1-2 teeth

Code	Description
SC-	152mm long
GI/264	178mm long
SC-	203mm long
GI/265	
SC-	
GI/266	

Tissue Forceps

Allis Tissue Forceps

Box joint

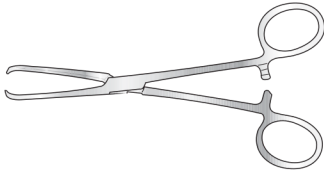

150mm long

Code	Description
SC-	3-4
GI/272	teeth 4-
SC-	5 teeth
GI/273	

190mm long

Code	Description
SC-GI/414	5-6 teeth

Duval Tissue Forceps

Box joint

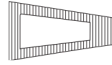
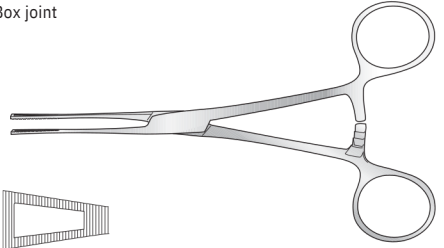

Code	Description
SC-GI/279	13mm wide, 203mm long

Littlewood Tissue Forceps

Box joint, 2-3 teeth

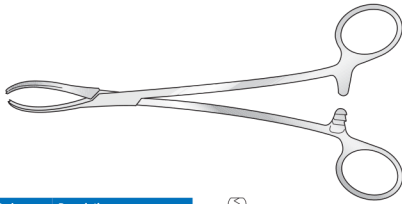

Code	Description
SC-GI/275	190mm long



Lane Tissue Forceps

Box joint, 1-2 teeth, fenestrated

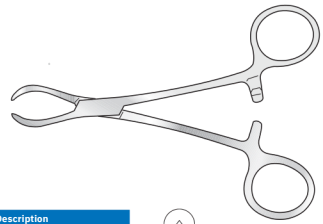

Code	Description
SC-	127mm
GI/280	long
SC-	152mm
GI/281	long
SC-	197mm
GI/282	long



Babcock Tissue Forceps

Box joint, serrated jaws

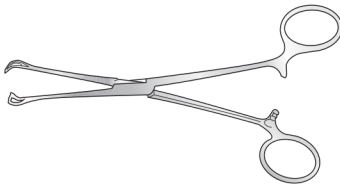

Code	Description
SC-	160mm long
GI/276	200mm long
SC-	230mm long
GI/277	
SC-	
GI/278	



Rutherford Morrison Tissue Forceps

Box joint

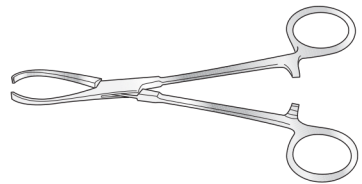

Code	Description
SC-GI/283	4-5 teeth, 152mm long



Shaw Tissue Forceps

Box joint

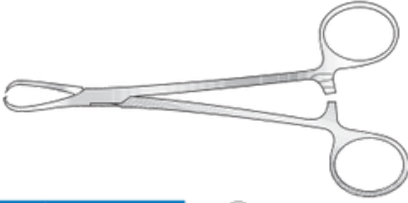

Code	Description
SC-GI/458	1-2 teeth, 178mm long



Guys Gallabin Suture-Holding Forceps

Screw joint, angled flt at blades

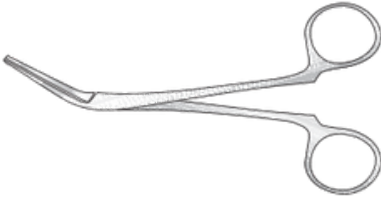

Code	Description
SC-GI/450	125mm
SC-GI/4402	long
	150mm
	long

Russian Dissecting Forceps

With fenestrated end



Code	Description
SC-GI/SH-5503b	150mm long
SC-GI/SH-5503	200mm long
SC-GI/403	230mm long
SC-GI/SH-5503a	250mm long



Special Offer

on SSD Essentials Pack

Top up your trays with these essentials . . .

CONTACT US FOR OUR OFFER PRICE

Halstead Mosquito Forceps

Straight/Curved
125mm (5")



Ramsey Sponge Holding Forceps

Serrated Jaws 241mm (9½")



Scalpel Blade Handle

No. 3



Spring Clip

Serrated Pattern, Stainless Steel for Fixing Slings to Leg Splints, also for Towel Clipping
6.3cm (2½") Wide



Spencer Wells Artery Forceps

Straight, Serrated Jaws



Email us to place your order

info@surgicalholdings.co.uk

Sponge Holding and Sterilising Forceps

Rampley Sponge Holding Forceps

Box joint, straight, serrated jaws

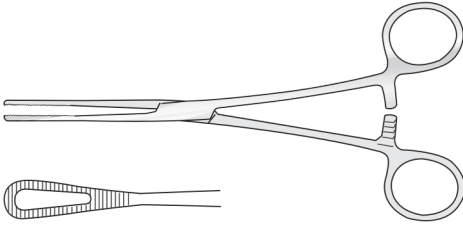

Code	Description
SC-	178mm
GI/353	long
SC-	241mm
GI/354	long

Lister Sinus Forceps

Box joint, serrated tip

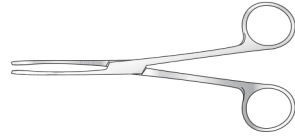

Code	Description
SC-	127mm
GI/367	long
SC-	152mm
GI/368	long
SC-	178mm
GI/369	long

Foerster Sponge Holding Forceps

Box joint, straight, serrated jaws

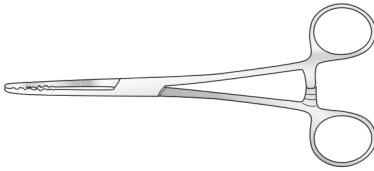

Code	Description
SC-GI/354a	178mm long

Cheatle Sterilizer Forceps

Screw joint

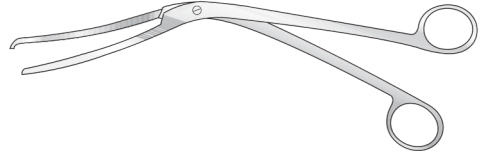

Code	Description
SC-GI/364	267mm long

Harrison Bowl Steriliser Forceps

Screw joint, angled, double jaw

Code	Description
SC-	356mm long
GI/365	457mm long
SC-	
GI/366	

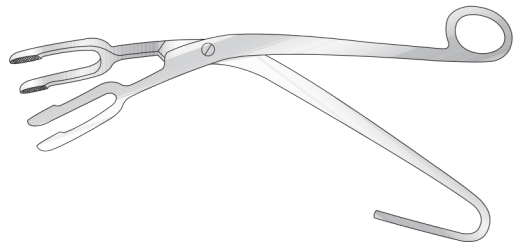

Hunter Splinter Forceps

Serrated grooved pointed jaws



Code	Description
SC-GI/360	115mm long

Michel Forceps

Box joint, double-ended, for inserting and removing clips stainless steel

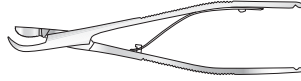

Code	Description
SC-GI/357	130mm long

Michel Skin Holding Forceps

With magazine for Michel clips

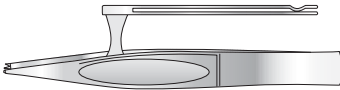

Code	Description
SC-GI/358	1-2 teeth, 127mm long

Michel Clip Extracting Forceps

Box joint

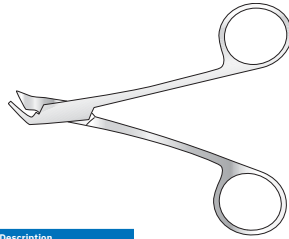

Code	Description
SC-GI/359	125mm long

Childe Approximating Forceps

With magazine for Michel clips

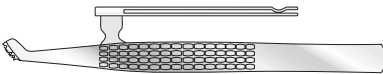

Code	Description
SC-GI/469	180mm long

Robins Anchoring Forceps

140mm long

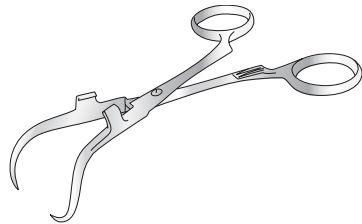

Code	Description
SC-GI/453	5mm with holder for diathermy leads
SC-GI/453a	13mm with holder for suction tubing

Premium Quality Stainless Steel Scissors

Dressing Scissors



Blunt/Blunt

Straight

Code	Description
SC-	130mm
GI/133	long
SC-	146mm
GI/136	long
SC-	165mm
GI/139	long

Curved

Code	Description
SC-GI/142	130mm long
SC-GI/143	146mm long
SC-GI/144	165mm long
SC-GI/145	185mm long
SC-GI/404	147mm long

With one serrated blade

Blunt/Sharp

Straight

Code	Description
SC-	130mm
GI/134	long
SC-	146mm
GI/137	long
SC-	165mm
GI/140	long

Sharp/Sharp

Straight

Code	Description
SC-	130mm
GI/135	long
SC-	146mm
GI/138	long

Curved

Code	Description
SC-GI/146	130mm long

Metzenbaum Scissors

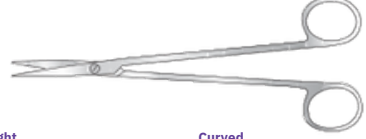

Straight

Code	Description
SC-GI/405	180mm long
SC-GI/406	147mm long
SC-GI/406a	200mm long
SC-GI/406b	230mm long
SC-GI/406c	250mm long
SC-GI/406d	280mm long

Curved

Code	Description
SC-GI/407	185mm long
SC-GI/408	147mm long
SC-GI/408a	200mm long
SC-GI/408b	230mm long
SC-GI/408c	250mm long
SC-GI/408d	280mm long

Mayo Scissors



Straight

Code	Description
SC-GI/409	140mm long
SC-GI/409a	160mm long
SC-GI/411	190mm long
SC-GI/411a	230mm long

Curved

Code	Description
SC-GI/410	140mm long
SC-GI/410a	160mm long
SC-GI/412	190mm long
SC-GI/412a	230mm long

Dressing Scissors, Left-Handed

With one black bow, 145mm long



Blunt/Blunt

Code	Description
SC-	Straight
GI/192	Curved
SC-	

GI/193

Blunt/Sharp

Code	Description
SC-	Straight
GI/194	Curved
SC-	
GI/195	

Sharp/Sharp

Code	Description
SC-	Straight
GI/196	Curved
SC-	
GI/197	

Littler Dissecting Scissors

Fine pattern, with eye for suture



Code	Description
SC-PL/001f	115mm long

Kilner Dissecting Scissors

Fine pattern



Code	Description
SC-PL/001a	115mm long

Fergusson Scissors

Angled on fl at



Code	Description
SC-GI/148	180mm long

Paynes Suture Scissors

Code	Description
SC-GI/152	100mm long



Ligature Stitch Scissors

Fine pattern

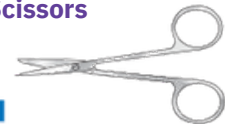

Code	Description
SC-GI/153	115mm long



Lister Bandage Scissors



Code	Description
SC-	147mm
GI/154	long
SC-	178mm
GI/155	long

Lister Bandage Scissors

Angled, with probe end

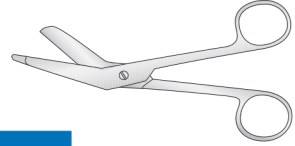

Code	Description
SC-	147mm
GI/361	long
SC-	178mm
GI/362	long

McIndoe Scissors

178mm long

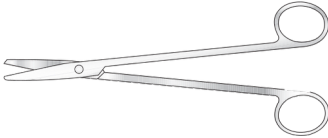

Code	Description
SC-GI/149	Straight
SC-GI/150	Curved on fl at
SC-GI/150sc	Supercut, curved

Thomas Strabismus Scissors

114mm long

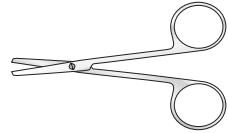

Code	Description
SC-OP/030	Straight
SC-OP/029	Curved

Heath Stitch Scissors

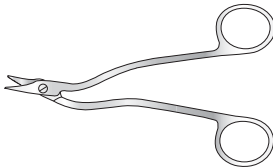

Code	Description
SC-GI/151	152mm long

“Careless” Scissors

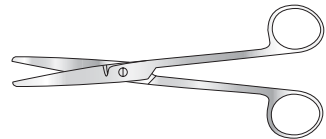

Code	Description
SC-GI/474	165mm long

Tubing Scissors

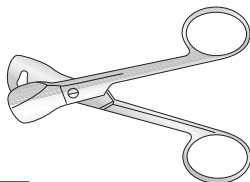

Code	Description
SC-GI/147	130mm long

Utility Scissors



Code	Description
SC-GI/466	190mm long

Tungsten Carbide Hard Insert Scissors

Dressing Scissors

Tungsten carbide hard insert, blunt/blunt

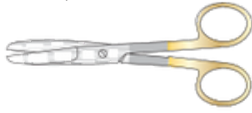

Straight

Code	Description
SC-GI/430	130mm
SC-GI/432	long
SC-GI/434	145mm
SC-GI/436	long
	165mm
	long
	185mm

Curved

Code	Description
SC-	130mm
GI/431	long
SC-	145mm
GI/433	long
SC-	165mm
GI/435	long

Dressing Scissors

Tungsten carbide hard insert, blunt/sharp



Straight

Code	Description
SC-	130mm
GI/423	long
SC-	145mm
GI/425	long
SC-	165mm
GI/427	long
SC-	185mm

Curved

Code	Description
SC-	130mm
GI/424	long
SC-	145mm
GI/426	long
SC-	165mm
GI/428	long

Dressing Scissors

Tungsten carbide hard insert sharp/sharp

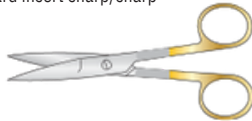

Straight

Code	Description
SC-	130mm
GI/437	long
SC-	145mm
GI/439	long
SC-	165mm
GI/441	long
SC-	185mm

Curved

Code	Description
SC-GI/438	130mm
SC-GI/440	long
SC-GI/442	145mm
	long
	165mm
	long

Baby Metzenbaum Scissors

Tungsten carbide, hard insert, 145mm long



Code	Description
SC-GI/445a	Straight
SC-GI/446a	Curved

Mayo Dressing Scissors

Tungsten carbide hard insert

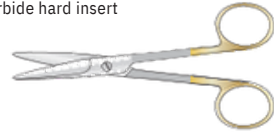

Straight

Code	Description
SC-GI/419	140mm long
SC-GI/419a	160mm long
SC-GI/421	190mm long
SC-GI/421a	230mm long

Curved

Code	Description
SC-GI/420	140mm long
SC-GI/420a	160mm long
SC-GI/422	190mm long
SC-GI/422a	230mm long

Mayo-Harrington Dressing Scissors

Tungsten carbide hard insert



230mm long

Code	Description
SC-	Straight
GI/417	Curved
SC-	
GI/418	

200mm long

Code	Description
SC-	Straight
GI/162a	Curved
SC-	
GI/413b	

Metzenbaum Scissors

Tungsten carbide hard insert

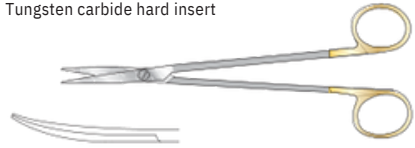

230mm long

Code	Description
SC-GI/445	145mm long
SC-GI/448	185mm long
SC-	230mm long
GI/471a	250mm long
SC-	280mm long
GI/471b	
SC-	
GI/471c	

200mm long

Code	Description
SC-GI/446	145mm long
SC-GI/449	185mm long
SC-GI/449a	200mm long
SC-GI/449b	230mm long
SC-GI/449c	250mm long
SC-GI/449d	280mm long

Ligature Scissors

Tungsten carbide hard insert, curved

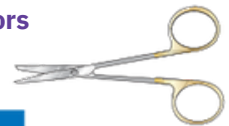

Code	Description
SC-GI/444	145mm
SC-GI/447	long
	185mm
	long

Tungsten Carbide Supercut Scissors

Mayo Harrington Scissors

Supercut, tungsten carbide

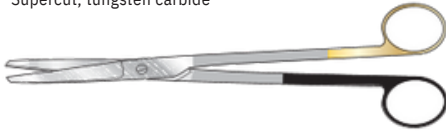

230mm long

Code	Description
SC-	Straight
GI/162	Curved
SC-	
GI/413	

200mm long

Code	Description
SC-GI/162b	Straight
SC-GI/413b	Curved

Mayo Scissors

Supercut, tungsten carbide



Straight

Code	Description
SC-GI/163	140mm long
SC-GI/163a	160mm long
SC-GI/165	190mm long
SC-GI/165a	230mm long

Curved

Code	Description
SC-GI/164	140mm long
SC-GI/164a	160mm long
SC-GI/166	190mm long
SC-GI/166a	230mm long

Metzenbaum Dissecting Scissors

Supercut, tungsten carbide



Straight

Code	Description
SC-GI/188tc	185mm long
SC-GI/188tca	200mm long
SC-GI/188tcb	230mm long
SC-GI/188tcc	250mm long
SC-GI/188tcd	280mm long

Curved

Code	Description
SC-GI/191tc	1 47m
SC-GI/189tc	m
SC-GI/186tca	185mm
SC-GI/188tcb	200mm
SC-GI/188tcc	230mm
SC-GI/188tcd	250mm
	280mm

Dressing Scissors

Supercut, tungsten carbide



Blunt/Blunt

Straight

Code	Description
SC-	130mm
GI/174	long
SC-	145mm
GI/176	long
SC-	165mm
GI/178	long

Blunt/Sharp

Straight

Code	Description
SC-	130mm
GI/167	long
SC-	145mm
GI/169	long
SC-	165mm
GI/171	long

Sharp/Sharp

Straight

Code	Description
SC-	130mm
GI/181	long
SC-	145mm
GI/183	long
SC-	165mm
GI/185	long
SC-	185mm
GI/187	long

Curved

Code	Description
SC-GI/175	130mm
SC-GI/177	long
SC-GI/179	145mm
SC-GI/180a	long
	165mm
	long
	185mm
	long

Curved

Code	Description
SC-GI/168	130mm
SC-GI/170	long
SC-GI/172	145mm
SC-GI/173a	long
	165mm
	long
	185mm
	long

Curved

Code	Description
SC-GI/182	130mm
SC-GI/184	long
SC-GI/186	145mm
SC-	long
GI/187a	165mm
	long
	185mm
	long

Guide for Gold and Black Bows

It's important to know the difference for the intended use of each scissor:



2 Gold Bows
Tungsten carbide insert or padding for a scissor



2 Black Bows
Supercut edge



1 Black and 1 Gold Bow
Supercut tungsten carbide



1 Black Bow (left ring)
Left-handed instrument

Supercut Operating Scissors

WITH TWO BLACK FOR IDENTIFICATION

Dressing Scissors

Supercut, blunt/blunt



145mm long

Code	Description
SC-	Straight
GI/160	Curved
SC-	
GI/161	

Dressing Scissors

Supercut, blunt/sharp



145mm long

Code	Description
SC-	Straight
GI/156	Curved
SC-	
GI/157	

Dressing Scissors

Supercut, sharp/sharp



145mm long

Code	Description
SC-	Straight
GI/158	Curved
SC-	
GI/159	

Mayo Scissors

Supercut



Straight

Code	Description
SC-	140mm
GI/166a	long
SC-	160mm
GI/166e	long
SC-	170mm
GI/166b	long

Curved

Code	Description
SC-	140mm
GI/166c	long
SC-	160mm
GI/166f	long
SC-	170mm
GI/166d	long

Boyd Scissors

Supercut, blunt/blunt



Code	Description
S C-T H O/0 47	180mm long

Metzenbaum Dissecting Scissors

Supercut



Straight (length)

Code	Description
SC-GI/190	1 47m
SC-GI/188	m
SC-GI/188a	185mm
SC-GI/188b	200mm
SC-GI/188c	230mm
SC-GI/188d	250mm
	280mm

Curved (length)

Code	Description
SC-GI/191	1 47m
SC-GI/189	m
SC-GI/186a	185mm
SC-GI/186b	200mm
SC-GI/186c	230mm
SC-GI/186d	250mm
	280mm

Stevens Tenotomy Scissors

Supercut



Curved/blunt

Code	Description
SC-OP/424	114mm
S C- O P/424 a	long
SC-OP/424gb	125mm
	long
	135mm

Curved/sharp

Code	Description
SC-OP/425	114mm
SC-OP/425a	long
SC-OP/425b	140mm
	long
	160mm

Code	Description
SC-OP/426	Straight/blunt, 114mm long
SC-OP/427	Straight/sharp, 114mm long
SC-OP/427c	Straight/sharp, 180mm long

With cutout, 110mm long

Code	Description
S C- O P/42	Straight/blunt
7a SC-	Curved/blunt
OP/427b	

Strabismus Scissors

Supercut



114mm long

Code	Description
SC-GI/475	Straight
SC-GI/475a	Curved

Iris Scissors

Supercut



114mm long

Code	Description
SC-OP/476	Straight
S C- O P/476 a	Curved

Bruce Clarke Needle Holder

Screw joint



Code	Description
SC-GI/205	127mm long

Lawrence Needle Holder

Fine jaw, 150mm long



Code	Description
SC-	
PL/012a	Tungsten carbide jaw
SC-	
PL/012b	

Crile-Wood Needle Holder

Straight, baby, fine



Code	Description
SC-GI/199	150mm long

Needle Holder

Surgical Holdings pattern, box joint, lightweight, with curved plain jaws and one o set bow for thumb



Code	Description
SC-GI/209	152mm long

Kilner Needle Holder

Box joint, cross-serrated jaw

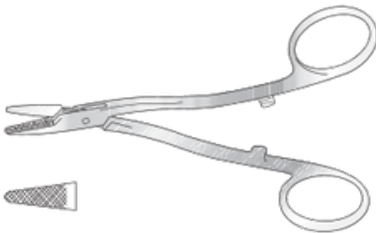

Code	Description
SC-GI/200	165mm
SC-GI/201	long
	133mm
	long

MacPhail Needle Holder

Screw joint, with one copper jaw



Code	Description
SC-	159mm long
GI/206	178mm long
SC-	209mm long
GI/207	
SC-	
GI/208	

Needle Holders

Mathieu Needle Holder

Screw joint



Code	Description
SC-	172mm long
GI/210	209mm long
SC-	243mm long
GI/211	
SC-	
GI/212	

Mayo Needle Holder

Box joint, straight

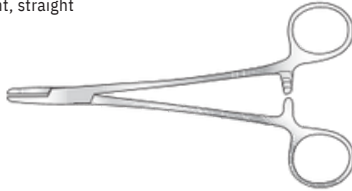

Wide cross serrated jaws

Code	Description
SC-	159mm long
GI/224	203mm long
SC-	
GI/398	



Narrow cross serrated jaws

Code	Description
SC-GI/225	159mm long

Naughton Morgan Needle Holder

Box joints, cross serrated jaws

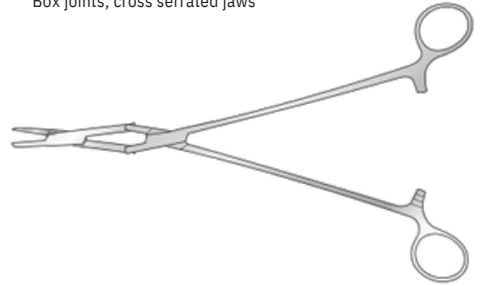

Tungsten carbide

Code	Description
SC-GI/399	185mm long
SC-GI/400	254mm long

Code	Description
SC-GI/401	185mm long
SC-GI/402	254mm long

Rochester-Mayo Needle Holder

Screw joint



Code	Description
SC-GI/213	178mm long

Choosing the most suitable needle size

Our tungsten carbide inserts are available in a variety of styles. Choosing the most suitable needle size for each procedure helps give the surgeon maximum grip and control.

Coarse 0.65mm

For powerful needle holder patterns and wire twisters. Maximum holding capabilities for heavy needles or wire.



Standard 0.5mm

Used, for example, in Mayo-Hegar, Mathieu Needle Holders. For needles 3-0 and larger.



Fine 0.4mm

For delicate needle holders such as Crile-Wood and DeBakey. For needles and sutures between 4-0 and 6-0.



Micro 0.2-0.3mm

For micro needle holders such as Castroviejo, Microvascular and Mini-Ryder. For delicate needles and sutures between 7-0 and 10-0.



Smooth

Smooth tungsten carbide surface reduces damage to delicate needles and suture of 6-0 and finer.





WITH TWO GOLD FOR IDENTIFICATION

Tungsten Carbide Needle Holders

Berry Needle Holder/Wire Twister

Tungsten carbide jaws

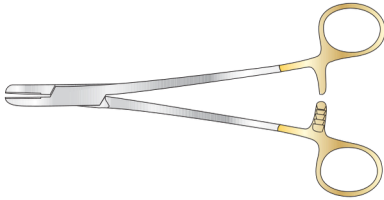

Code	Description
SC-GI/467	200mm long

Finochietto Needle Holder

Tungsten carbide jaws

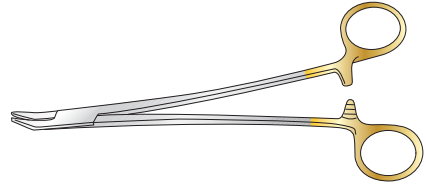

Code	Description
SC-	215mm long
GI/222	265mm long
SC-	
GI/223	

Crile-Wood Needle Holder

Tungsten carbide insert, box joint, satin fi nish, straight

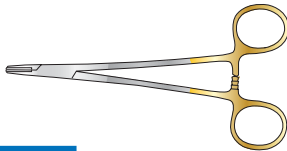

Code	Description
SC-	159mm
GI/217	long
SC-	178mm
GI/218	long
SC-	150mm
GI/198	long

Halsey Needle Holder

Tungsten carbide insert, box joint, satin fi nish, straight

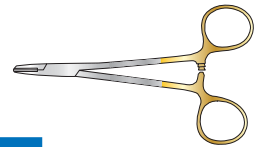

Code	Description
SC-GI/220	127mm long

Derf Needle Holder

Tungsten carbide insert



Code	Description
SC-GI/BUPHF002	115mm long

Kilner Needle Holder

Tungsten carbide insert

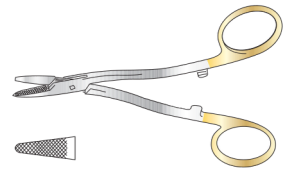

Code	Description
SC-GI/221	140mm long

Tungsten Carbide Needle Holders

i WITH TWO GOLD FOR BOWS IDENTIFICATION

Masing Needle Holder

Tungsten carbide insert, one angled bow

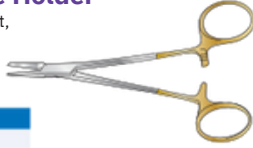

Code	Description
SC-GI/009R	130mm long

Nievert Needle Holder

Tungsten carbide insert, box joint, satin fi nish, straight

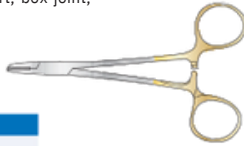

Code	Description
SC-GI/219	127mm long

DeBakey Needle Holder

250mm long

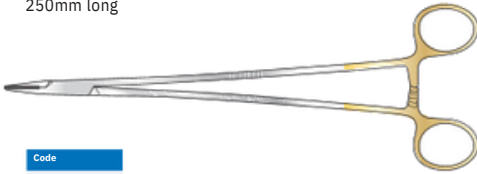

Code
THO/SC-5642a

Ryder Needle Holder

Tungsten carbide insert, box joint, satin fi nish, straight



0.2mm jaw pitch

Code	Description	Code	Description
SC-GI/SH-	135mm	SC-GI/SH-	135mm
5197a	SC- long	5198a	SC- long
GI/SH-5197b	155mm	GI/SH-5198b	155mm
SC-GI/SH-	long	SC-GI/SH-	long
5197c	SC- 175mm	5198c	SC- 175mm
GI/SH-5197d	long	GI/SH-5198d	long
	210mm		210mm
	long		long

0.4mm jaw pitch

Code	Description	Code	Description
SC-GI/SH-	135mm	SC-GI/SH-	135mm
5197a	SC- long	5198a	SC- long
GI/SH-5197b	155mm	GI/SH-5198b	155mm
SC-GI/SH-	long	SC-GI/SH-	long
5197c	SC- 175mm	5198c	SC- 175mm
GI/SH-5197d	long	GI/SH-5198d	long
	210mm		210mm
	long		long

Sarot Needle Holder

Diamond jaw, tungsten carbide, gold plated bows



Code	Description
SC-GI/451	181mm long

Tungsten Carbide Needle Holders

Features and Benefits

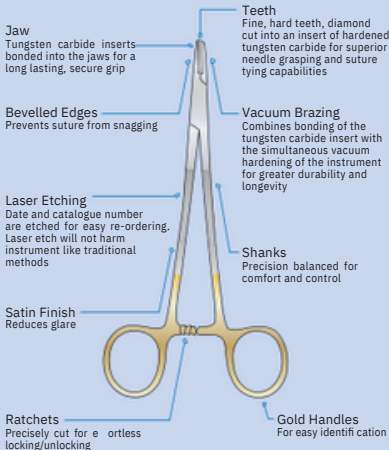

Mayo-Hegar Needle Holder

Tungsten carbide insert, box joint, satin fi nish, straight



Code	Description
SC-	130mm long
GI/472	159mm long
SC-	178mm long
GI/214	209mm long
SC-	

LONGER SIZES AVAILABLE

GI/215
SC-
GI/216

Combined Scissor and Needle Holders

Olsen-Hegar Scissor/Needle Holder

With tungsten carbide insert

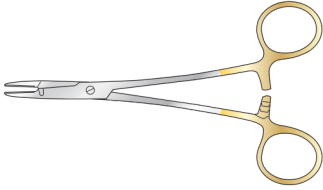

Code	Description
SC-	147mm
GI/229	long
SC-	165mm
GI/230	long

Olsen-Hegar Scissor/Needle Holder

Screw joint

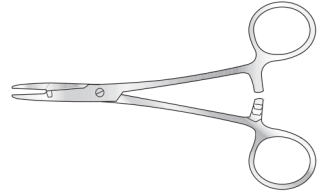

Code	Description
SC-	140mm
GI/226	long
SC-	165mm
GI/227	long
SC-	190mm
GI/228	long

Gillies Scissor/Needle Holder

Right-hand, with tungsten carbide insert

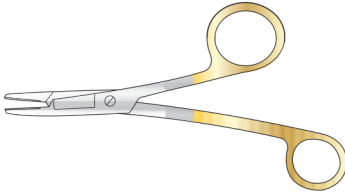

Code	Description
SC-GI/235	158mm long

Gillies Scissor/Needle Holder

Heavy pattern, 158mm long

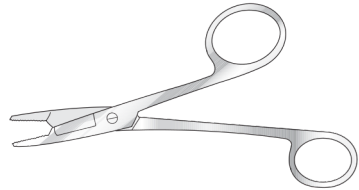

Code	Description
SC-	Right-hand
GI/233	Left-hand
SC-	
GI/234	

Gillies Scissor/Needle Holder

158mm long

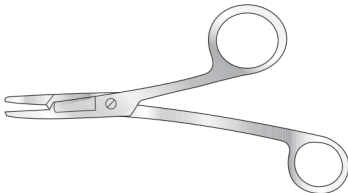

Code	Description
SC-	Right-hand
GI/231	Left-hand
SC-	
GI/232	

Foster Gillies Scissor/Needle Holder

Fine pattern



Code	Description
SC-GI/236	127mm long

Bag and Towel Clips

Spring Clip

Serrated pattern, stainless steel, for fixing slings to leg splints, also for towel clipping

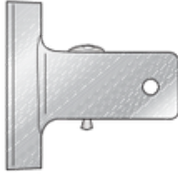

Code	Description
SC-GI/344	63mm wide

Spring Bag Clip

Serrated



Code	Description
SC-GI/345	26mm wide

Jones Towel Clip

Superior quality spring forcep type



Code	Description
SC-GI/346	89mm long

Shardles Towel Clip

Spring curved, cross action



Code	Description
SC-GI/347	77mm long

Backhaus Towel Clip

Superior quality, box joint



Code	Description
SC-GI/348	89mm long
SC-GI/348a	102mm
SC-GI/349	long
	130mm
	long

Moynihah Towel Clip

Screw joint, 2-2 teeth, for sides of incision

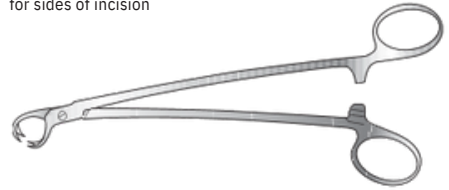

Code	Description
SC-GI/470	191mm long

Ball and Socket Towel Forceps

Box joint



Code	Description
SC-	89mm long
GI/350	115mm
SC-	long
GI/351	140mm
SC-	long
GI/352	

Goligher Retractor

Complete with 2 centre blades:
1 x 90mm wide x 50mm deep
1 x 90mm wide x 90mm deep

and 2 pairs of lateral blades:
1 pair 25mm wide x 45mm deep
1 pair 50mm wide x 90mm deep

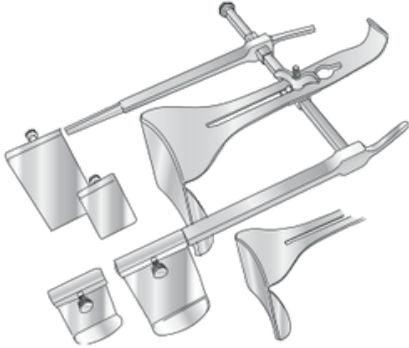

Code
SC-GI/305

Balfour Abdominal Retractor

Trivalve, frame 203mm

Child

102mm opening, 51mm deep lateral blades, 38mm deep centre blade

Adult

178mm opening, 64mm deep lateral blades, 44mm deep centre blade

Extra large

178mm opening, 102mm deep lateral blades, 108mm deep centre blade

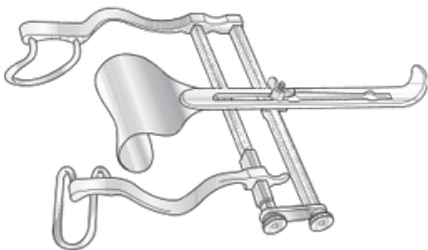

Code	Description
SC-	Child
GI/373	Adult
SC-	Extra large
GI/374	
SC-	
GI/375	

Miles Retractor

Complete with 2 centre blades:
1 x 90mm wide x 50mm deep
1 x 90mm wide x 75mm deep

and 2 pairs of lateral blades:
1 pair 80mm wide x 35mm deep
1 pair 80mm wide x 75mm deep

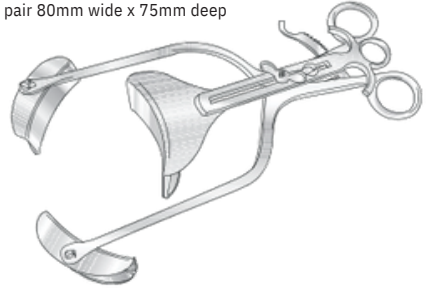

Code	Description
SC-GI/376	340mm long

OTHER BLADE SIZES AVAILABLE

Balfour Abdominal Retractor

Bivalve, baby

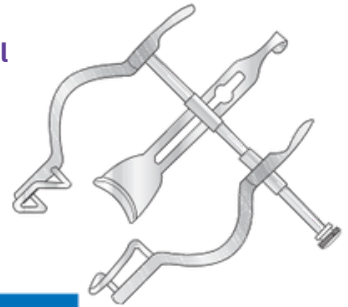

Code	Description
SC-GI/372	Fully open 89mm

Berkeley Abdominal Retractor

Parallel action

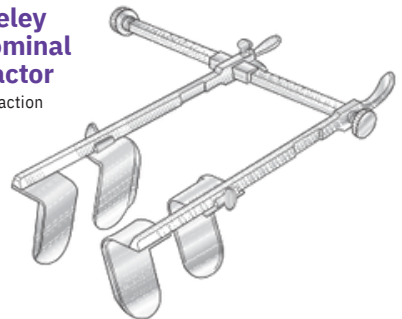

Code	Description
SC-GI/461	Blades 35mm x 60mm deep, 215mm long

Turner Warwick Retractors

Turner Warwick Universal Self Retaining Retractor

Code	Description
SC-GJ/520	With frames A/B/C/D and blades A/B/C/D/E/F/K/L
SC-GJ/521-A	Circular frame A only 178mm
SC-GJ/521-B	Circular frame B only 229mm
SC-GJ/521-C	Circular frame C only 305mm
SC-GJ/521-D	Oval frame D only 475mm x 330mm
SC-GJ/521-E	Oval frame E only 370mm x 300mm

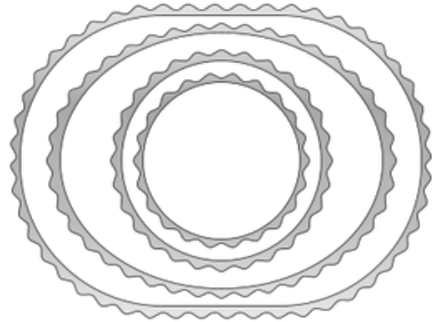

Turner Warwick Needleholder with Tungsten Carbide Jaws

Our needleholders have a short bow

Code	Description
SH-5835	230mm long
SH-5835A	200mm long

Blade A



Code	Description
SC-GJ/522-A	Blade only - 19mm x 76mm

Blade B

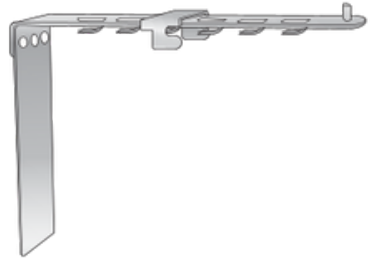

Code	Description
SC-GJ/522-B	Blade only - 38mm x 102mm

Blade C

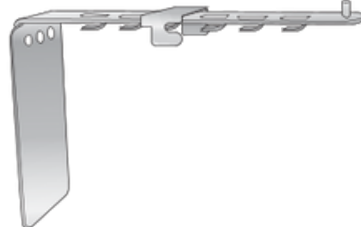

Code	Description
SC-GJ/522-C	Blade only - 57mm x 89mm

Blade D

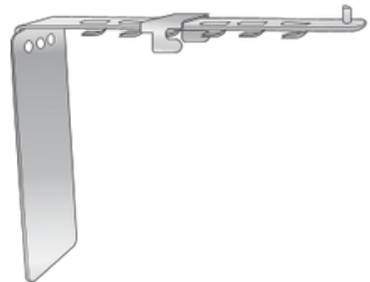

Code	Description
SC-GJ/522-D	Blade only - 57mm x 114mm

Blade E



Code	Description
SC-GI/522-E	Blade only - curved stainless steel blade 51mm x 38mm

Blade F

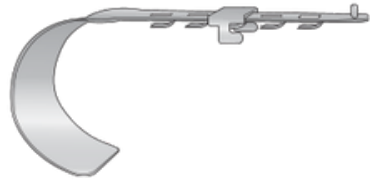

Code	Description
SC-GI/522-F	Blade only - curved stainless steel blade 76mm x 60mm

Blade G

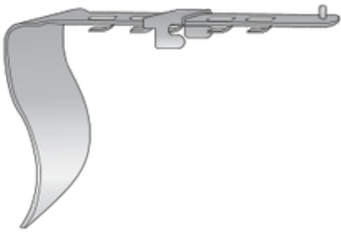

Code	Description
SC-GI/522-G	Blade only - fl at stainless steel blade 89mm x 60mm

Blade J



Code	Description
SC-GI/522-J	Blade only - single hook, 13mm deep

Blade K

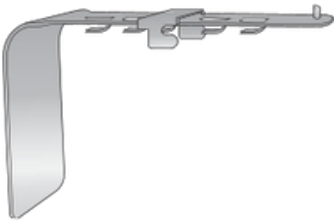

Code	Description
SC-GI/522-K	Blade only - fl at with clip 55mm x 90mm

Blade L

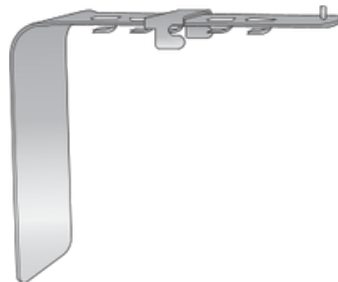

Code	Description
SC-GI/522-L	Blade only - fl at with clip 55mm x 120mm

Retractors

Collin Retractor

110mm fully open, 235mm long

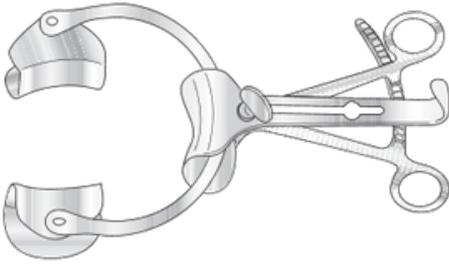

Code	Description
SC-GI/322	Complete with centre blade 55 x 40mm and one pair of blades 38mm x 60mm
SC-GI/322a	Without centre blade

Gelpi Retractor

Self retaining



Code	Description
SC-	140mm
GY/013a	long
SC-	178mm
GW/013b	long

Joll Thyroid Retractor

Self retaining, with lock-in nut

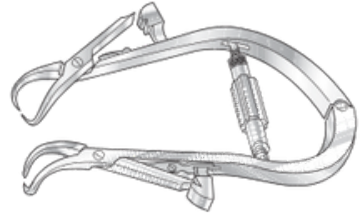

Code	Description
SC-GI/363	152mm long

Gossett Abdominal Retractor

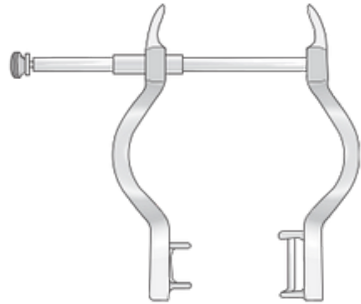

Code	Description
SC-GI/303	Large, fully open 185mm long
SC-GI/304	Small, fully open 95mm long

Pozzi Abdominal Retractors

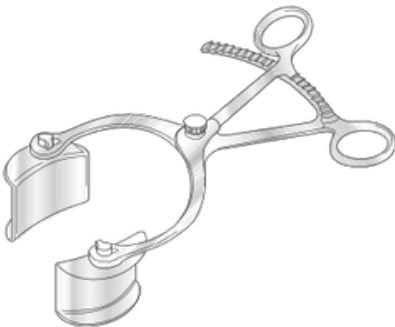

Code	Description
SC-GI/370	Swivel blades: 38 x 60mm, bivalve, 254mm long

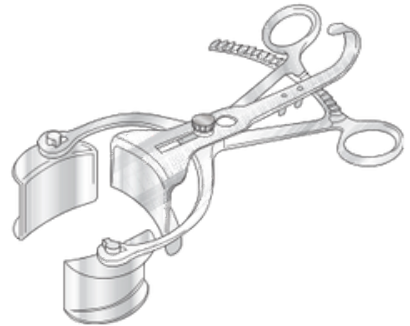

Code	Description
SC-GI/371	Swivel blades: 38 x 59mm, trivalve, 203mm long

Bowlby Dilator

Curved

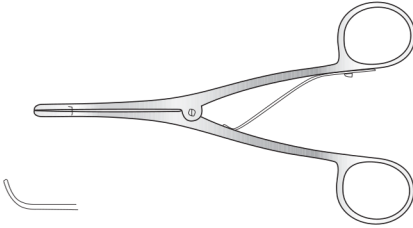

Code	Description
SC-GI/495	145mm long

Travers Retractor

Self retaining with internal rack, 210mm long

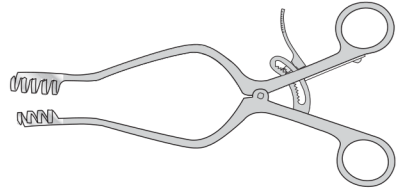

Code	Description
SC-GI/323	4 x 5 teeth, 95mm fully open

Irwin Retractor

Self retaining, with cam rack, 4 x 4 teeth

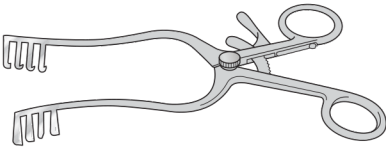

Code	Description
SC-GI/324	178mm long

West Retractor

Self retaining, 140mm long

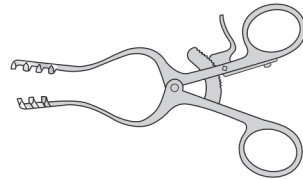

Code	Description
SC-GI/326	3 x 4 teeth, 60mm fully open
SC-GI/326cr	3 x 4 teeth, 60mm fully open, with cam rack

Norfolk and Norwich Retractor

4 x 5 teeth 50mm blades x 223mm long

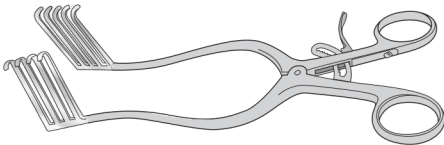

Code	Description
SC-GI/325	Standard rack

Weitlander Retractor

3-4 teeth

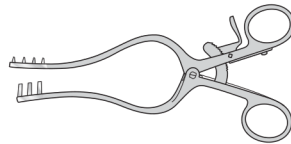

135mm long

Code	Description
SC-GI/496	Blunt
SC-GI/496a	Sharp
SC-GI/496b	Sharp, 2-3 teeth
SC-GI/496c	Blunt, 2-3 teeth

165mm long

Code	Description
SC-GI/497	Blunt
SC-GI/497a	Sharp

Retractors

Kocher Retractor



230mm long

Code	Description
SC-GI/378	36 x 20mm blade

250mm long

Code	Description
SC-	67 x 25mm blade
GI/378a	80 x 42mm blade
SC-	80 x 50mm blade
GI/378b	80 x 60mm blade
SC-	
GI/378c	
SC-	
GI/378d	

Kocher Langenbeck Retractor

215mm long



Code	Description
SC-GI/336sp	25 x 6mm blade
SC-GI/379a	35 x 8mm blade
SC-GI/379b	35 x 11mm blade
SC-GI/379c	blade 35 x 11mm
SC-GI/379sp	15mm blade 41 x 11mm blade

Code	Description
SC-THO/cutsp015	55 x 11mm blade
SC-GI/379d	70 x 15mm blade
SC-GI/379e	80 x 12mm blade
SC-GI/379f	80 x 16mm blade

Langenbeck Retractor

Single ended



Code	Description
SC-GI/336	Blade 22mm x 6mm
SC-GI/337	Blade 45mm x 13mm
SC-GI/337a	Blade 65mm x 13mm
SC-GI/338a	Blade 75mm x 25mm
SC-GI/338a1	Blade 65mm x 25mm

Landon Retractor



Code	Description
SC-GI/494	230mm



Canny Ryall Navy Retractor

Double-ended, with one single hook blade 5mm wide, and one fenestrated blade



Code	Description
SC-GI/343	Fenestrated blade 16mm wide, 190mm long
SC-GI/343a	Fenestrated blade 19mm wide, 190mm long
SC-GI/343b	Fenestrated blade 25mm wide, 220mm long
SC-GI/343c	Fenestrated blade 30mm wide, 220mm long

Canny Ryall Army Retractor

Double prong, 13mm wide, 165mm long



Code	Description
SC-GI/342	Large, 19mm wide
SC-GI/342a	Small, 11mm wide



Czerny Retractor

Double ended



Code	Description
SC-GI/341	171mm long

Lane Retractor

Double ended blade, 229mm long



Code	Description
SC-GI/339	13mm x 19mm wide
SC-GI/340	25mm x 32mm wide

Retractors

Durham Retractor

With fenestrated blade, 216mm long



Code	Description
SC-GI/300	10mm wide
SC-GI/301	14mm wide
SC-GI/302	20mm wide

Ballance (Volkman) Retractor

203mm long



Sharp

Code	Description
SC-GI/463	1 prong
SC-GI/463a	2 prong
SC-GI/463b	3 prong
SC-GI/463c	4 prong
SC-GI/463d	6 prong

Blunt

Code	Description
SC-GI/463e	1 prong
SC-GI/463f	2 prong
SC-GI/463g	3 prong
SC-GI/463h	4 prong
SC-GI/463i	6 prong

Volkman Retractor



Code	Description
SC-OR/400	Sharp, 220mm long
SC-OR/400a	Blunt, 220mm long
SC-OR/400b	Sharp, 245mm long

Kilner Retractor

Double ended, cat's paw



Code	Description
SC-PL/056	152mm long

Kocher Retractor



Code	Description
SC-OR/N036c	Sharp, 205mm long
SC-OR/N036	Sharp, 220mm long
SC-OR/N036b	Blunt, 220mm long

Senn-Miller Retractor

170mm long



Code
SC-SH/5881

Single Hook Retractor

Sharp



Code	Description
SC-	152mm long
GI/SH5671	Half size, fi ne
SC-PL/065b	

Gillies Skin Hook

Solid handle, 190mm long



Code	Description
SC-PL/065a	Standard, fi ne
SC-PL/065b	Half size, fi ne

Dissectors and Probes

MacDonald Dissector Double Ended



Code	Description
SC-GI/285	191mm long



Probe, Sinus Silver



Code	Description
SC-GI/464	152mm long

Brodie Director Probe Ended, Silver Plated



Code	Description
SC-GI/286	165mm long

Probe, Fish Tail Silver Plated



Code	Description
SC-	127mm long
GI/293	152mm long
SC-	203mm long
GI/294	254mm long
SC-	
GI/295	
SC-	
GI/296	

Watson Cheyne Dissector

Fine, double-ended, with probe end



Code	Description
SC-GI/287	127mm long
SC-GI/288	191mm long
SC-GI/288a	230mm long
SC-GI/288b	255mm long

Jobson Horne Probe Dressing (Aural)

With one fl at tapered end, serrated edge and one small ring end, stainless steel



Code	Description
SC-	140mm
GI/297	long
SC-	178mm
GI/298	long

Probe, Malleable Silver Plated



Code	Description
SC-GI/289a	127mm long
SC-GI/289	152mm long
SC-GI/290	178mm long
SC-GI/291	203mm long
SC-GI/292	255mm long
SC-GI/292a	305mm long

Bookwalter® Retractor Kit III

A table-fixed retractor system designed by surgeons to efficiently and reliably hold surgical instruments in place during surgery while allowing greater visibility.

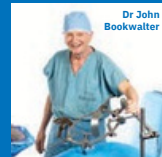

Kit includes Bookwalter® Kit: Table Post and Coupling, Horizontal Flex Bar, Segmented Rings, Tilt Ratchet Mechanism, Kelly Retractors, Blades and Ratchets

Contact us for full details at info@surgicalholdings.co.uk